



Working at heights on slippery uneven surfaces can be very HAZARDOUS.

Every effort should be made at all times to reduce the risk of injury and property damage (Contact your local Work Cover Authority or local council for site specific safety regulations)

## WHEN ENGAGED IN WORK AT HEIGHTS

- Use a safety harness anchored correctly (have a contingency with an extra person to assist any potential falls)
- Wear non slip shoes, do not over extend your weight transfer at any time
- Protective clothing from the sun and the mesh are to be worn, (i.e. hats, gloves, sunscreen)
- Do not work in the rain or on wet surfaces
- The mesh itself can be very slippery, do not step on it or leave off cuts lying around
- Use only rated Ladders and scaffolds setup suitably on stable even ground
- Make sure there are no overhead power lines in your vicinity
- Ensure your tools are well maintained, it will give you a better result
- Keep children and pets away from the work area at all times
- Handle the product with care, (wear gloves) it does have sharp edges
- Use a ladder safe bracket to reduce chance of ladder slipping or damaging gutters

Whats included in the kit:

- 
- 10M premium mesh (500mm wide)
- 110 Self drilling screws
- 10m of Colourbond trim

Tools needed

- Cordless drill/screw gun with correct drives, drill bits
- Tinsnips,
- Any applicable safety equipment (harness)

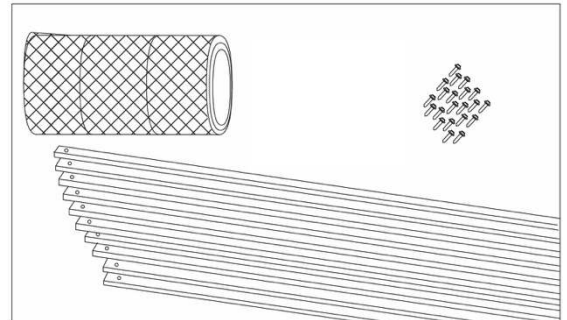

## **1) Gutter cleaning**

- Ensure your gutter is clear of all debris prior to the installation
- If you are planning on hosing out your gutters be careful of the wet roof surfaces left behind
- Wear gloves and be careful not to cut your hands on the gutter or roof, the iron roofs can be especially sharp.

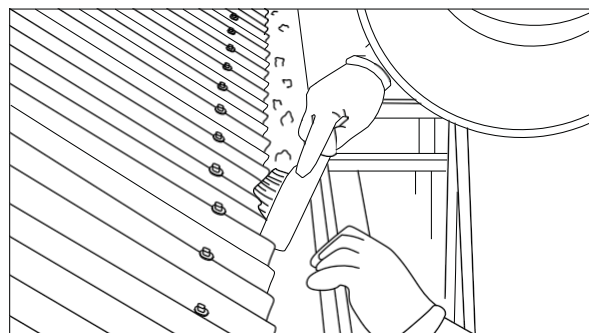



**2) Installing the mesh (trim to gutter)**

- Roll out the mesh starting at one end of the gutter, leave a little overlap where you start and cut off at end allowing a small overlap again.

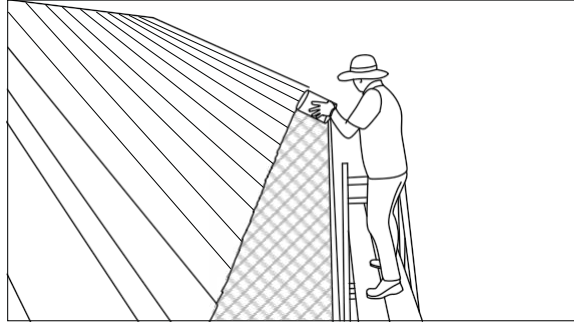

**3) Fix the mesh to the gutter by using the pre drilled pilot hole in each trim piece.**

- Place the first trim on the starting end of the gutter, ensure the mesh is all the way under the trim between the trim and the gutter. Ensure the mesh is laid evenly then screw the trims on with the provided self drilling screws every 250mm
- The next trim is then placed up against the last trim, align the predrilled hole and continue screwing the trims like this until the gutter run is complete.
- When trimming a corner you can cut part way through a trim and bend to make a clean angle

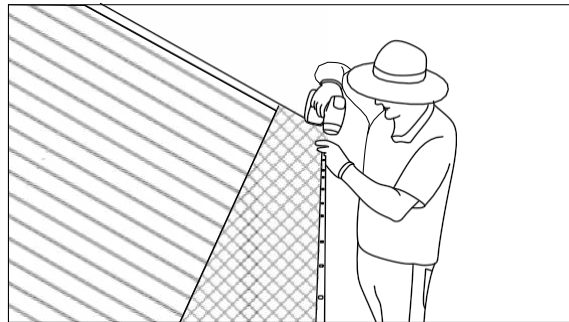

**4) Make approximately three cuts per each tile width to allow mesh to mould to the roof shape, then tuck the mesh under the second row of tiles.**

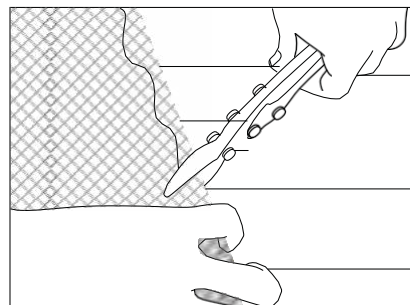
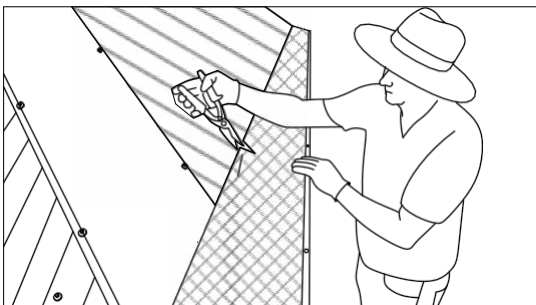



**5) Then tuck the mesh under the second row of tiles.**

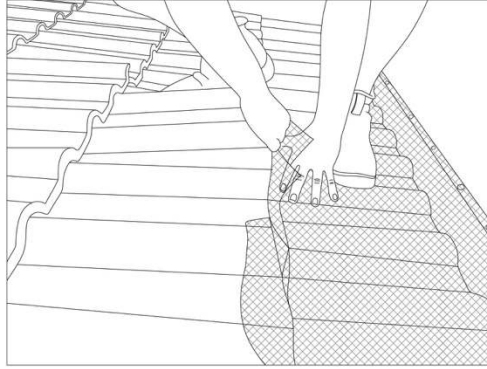

**If you can install under the ridge cap it would be ideal, however if you cannot.**

- Neatly cut the mesh to fit around the roll of ridge capping and trim to the other side.
- Cut the mesh short for any tiles that sit under the ridge cap and only push the mesh under the tile
- Repeat procedure on opposite side of the ridge by joining the mesh together with screws.

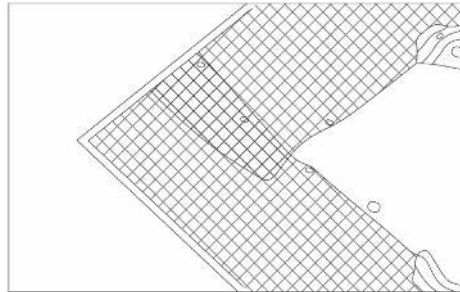

**MAINTENANCE**

In most cases debris will clear off the roof with the wind. In areas of high levels of debris you may need to gently sweep or blow it off the roof. If your gutters have the correct fall, dirt and small particles will flush out with the rain, if this is not the case you may need to flush the gutters from time to time. Please note that the mesh on your roof can be very slippery, do not walk on the mesh to reduce chance of damage and a fall.